

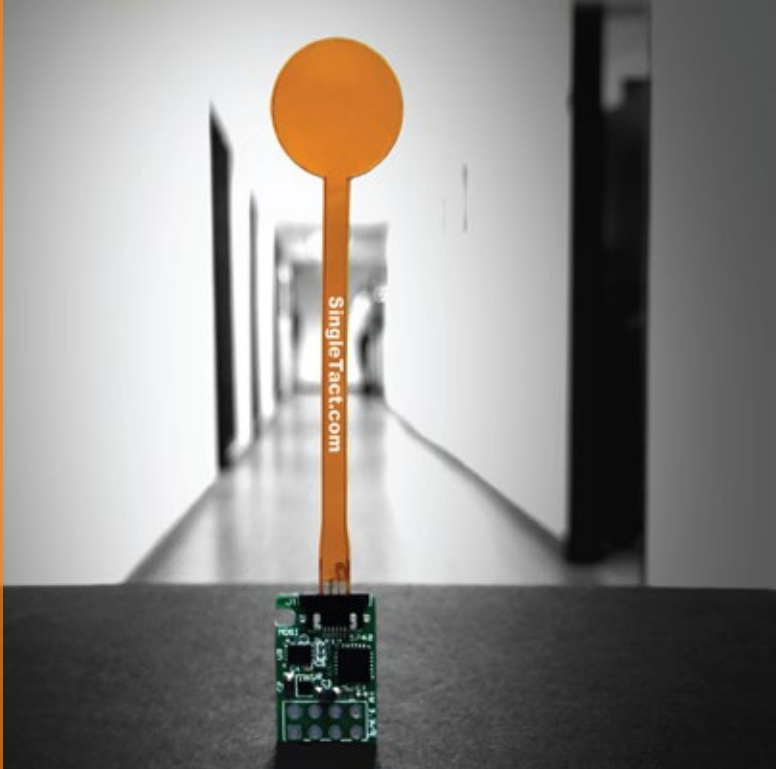



Congratulations on your purchase of a SingleTact USB Sensor System!

This quick start guide will show you how to set up your SingleTact USB Sensor System and begin taking recorded measurements. The SingleTact USB board allows for easy implementation and evaluation of SingleTact pressure sensors, without the need for external microcontrollers or wiring circuits.



	REPEATABILITY
	SingleTact has repeatability errors that are less than 1.0% of FSR.
	ACCURACY
	SingleTact has the best accuracy among thin film force sensors.
	EASY TO USE
	SingleTact Sensors are designed to be versatile, but user-friendly.
	CUSTOM DESIGN
	SingleTact can be customized for your OEM applications.

Getting Started Notes

- Each SingleTact USB board can interface with a single SingleTact pressure sensor, and can output data directly to our freely available SingleTact Data Acquisition (DAQ) software.
- Multiple USB boards can be connected to a single PC and display on the DAQ software.
- The SingleTact USB board does not have an analogue output. Instead, a pressure-variable LED is provided onboard to aid in pressure reporting.
- The SingleTact USB board is compatible with our full range of SingleTact pressure sensors and tail extenders.

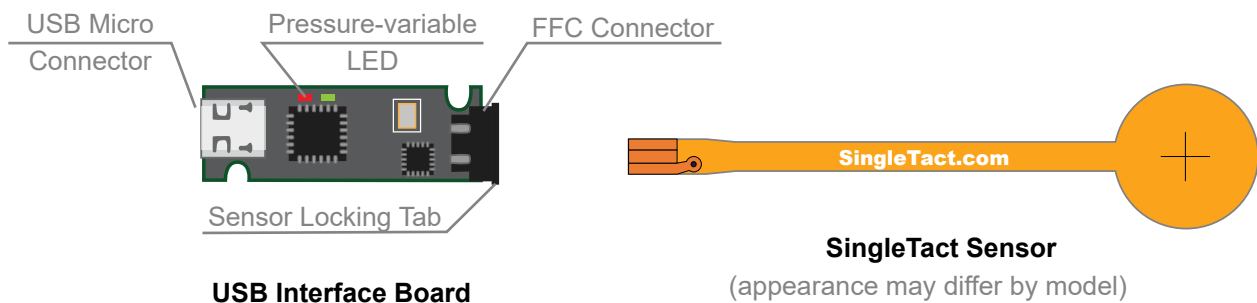

1 Connecting the Sensor and USB Board

1. Pull out the Sensor Locking Tab gently (it will only move about 2mm)
2. Insert the SingleTact Sensor into the FFC Connector, matching the orientation shown in diagram to right
3. Push the Sensor Locking Tab back in
4. Insert the supplied USB Micro cable into the USB Micro Connector
5. Plug the USB cable into an available USB port on your PC or laptop.

To test that your SingleTact USB board and SingleTact pressure sensor are connected correctly, lightly press on the sensor face with your finger. You will see a red LED light up when you load the sensor. The brightness of the LED is proportional to the applied load.

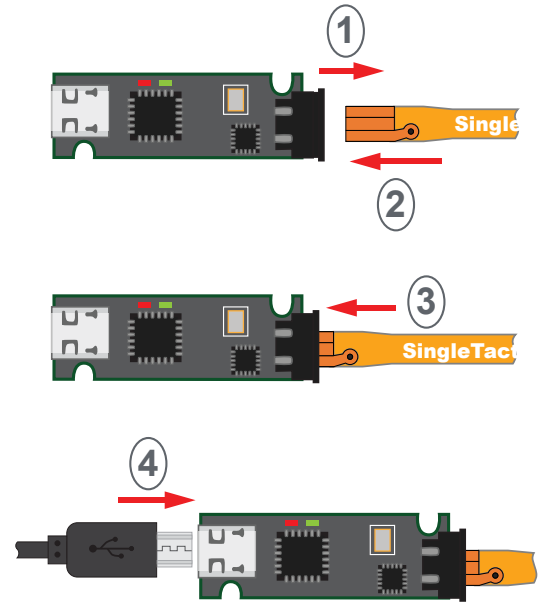

2. Taking Measurements

The SingleTact Data Acquisition (DAQ) software is the graphic user interface (GUI) and recording tool for SingleTact pressure sensors.

1. Download the executable app from:
<https://www.singletact.com/software-download/>
2. Connect the assembled SingleTact USB system(s) to the PC
3. Run 'SingleTact Demo.exe'
4. The sensor data will be shown on the GUI graph
 - a. You can choose whether to interface with a single sensor or all sensors at once
 - b. The sensor data can be saved as a .CSV file for later analysis using the GUI

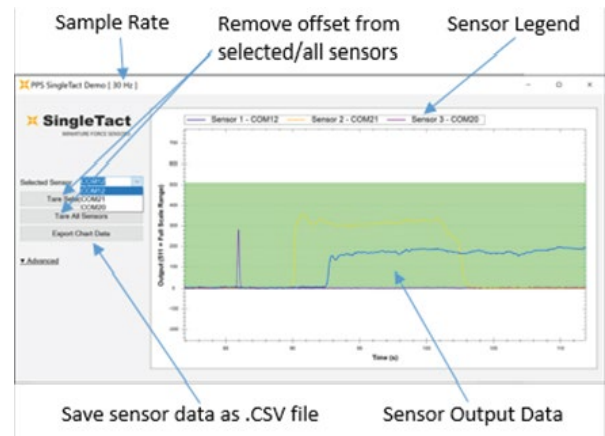

You are now ready to use your SingleTact system to make pressure and force measurements!

NOTE: The GUI is scaled from 0 to 511, and so the measured force will be given by the following equation (unless otherwise stated on the GUI):

$$Force = \frac{Output \times Sensor \text{ Rating}}{512} (N)$$

3. Additional Information

- For more information, such as how to use SingleTact Tail Extenders, Advanced DAQ Options, and Troubleshooting, please see the **SingleTact Manual**.
- The manual can be found online at: http://www.singletact.com/SingleTact_Manual.pdf
- Assistance for your specific application may be found on <http://www.singletact.com/faq>
- For all else, send us an email at info@singletact.com